

HCNS Series

High Power Diffused Ring Lights



Product Features

- Unique illumination structure effectively provides brighter and more uniform diffused light
- High illumination uniformity and large irradiated area
- High reflective & uneven surface defect inspection
- Food & medical & SEMI packaging appearance inspection
- Compact, easy to install, wide application

Model Guide

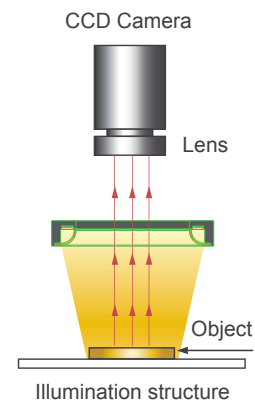
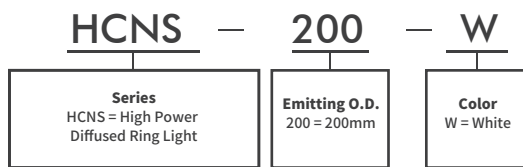

Specification Table

Model	Color	Current / Power	Dimensions (mm)			Diagrams
			O.D.	I.D.	Height	
HCNS-75	●	Continuous : 0.35A/6.5W Strobe : 0.75A/17W	91	41	26	1
	● ●	Continuous : 0.35A/7W Strobe : 0.79A/19W	91	41	26	
	○	Continuous : 0.35A/7W Strobe : 0.7A/16.5W	91	41	26	
HCNS-100	●	Continuous : 0.5A/10W Strobe : 1A/24W	116	66	26	2
	● ●	Continuous : 0.5A/10.5W Strobe : 1A/24W	116	66	26	
	○	Continuous : 0.5A/10.5W Strobe : 0.93A/22W	116	66	26	
HCNS-150	●	Continuous : 1A/20.5W Strobe : 1.5A/34.5W	166	116	26	3
	● ●	Continuous : 1A/22W Strobe : 1.5A/36W	166	116	26	
	○	Continuous : 1A/24W Strobe : 1.8A/43W	166	116	26	
HCNS-200	●	Continuous : 1.2A/24W Strobe : 2A/48W	216	166	28	4
	○ ● ●	Continuous : 1.2A/26W Strobe : 2A/48W	216	166	28	

※ Only operated by constant current LED driver, and please pay attention to rated current

◆ Uniformity

▲ HCNS-75-W

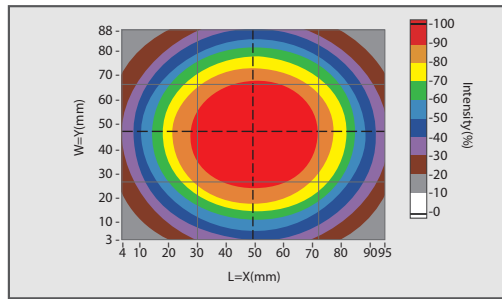

▲ HCNS-100-W

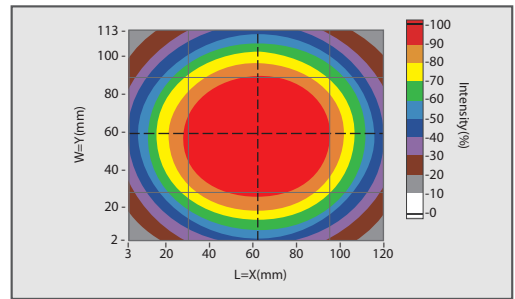

▲ HCNS-150-W

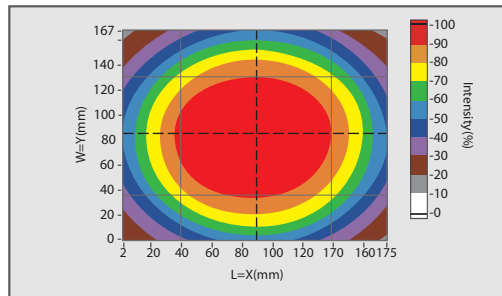

▲ HCNS-200-W

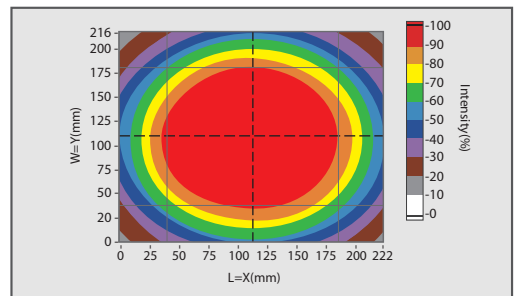

◆ Dimensional Drawing

(mm)

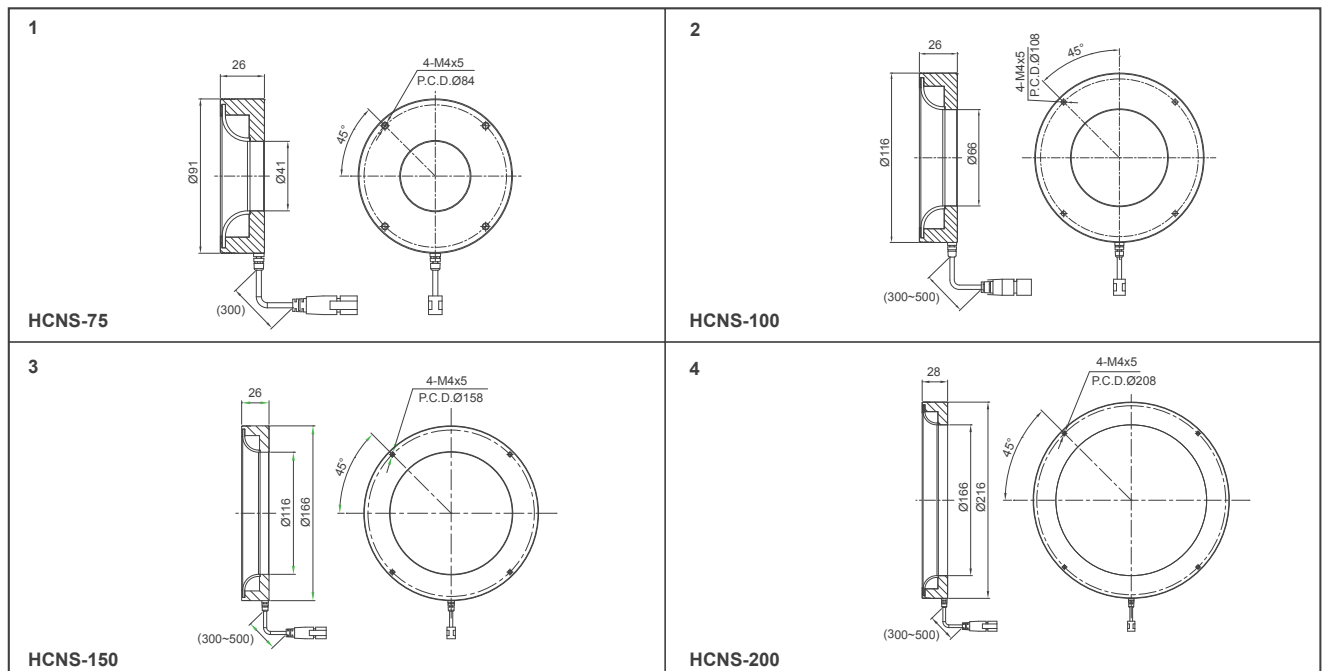

◆ Case Pictures

